

GRUA TORRE / TOWER CRANE

GRUE A TOUR / БАШЕННЫЙ КРАН /

KULE VINÇ / رافعة برجية

J37NS



UNE 58-101
FEM 1001

UNE-EN-ISO 9001

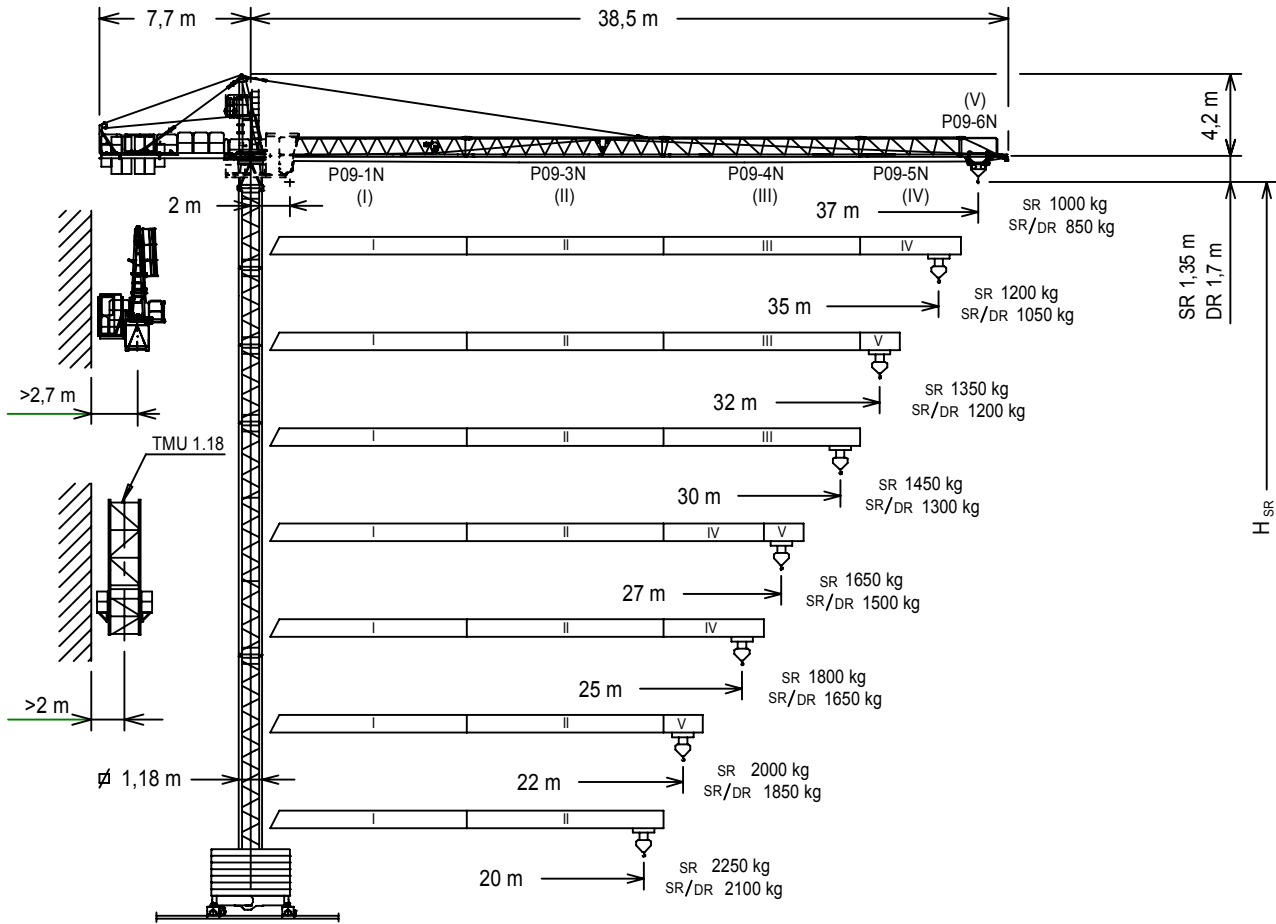

$$H_{DR} = H_{SR} - 0,35$$

Altura máxima bajo gancho sin arriostrar (m).
Maximum height under hook without fastening (m).
Hauteur maximale sous crochet sans ancrage (m).

$$H_{SR} = \text{Максимальная высота под крюком без крепления (m).}$$

Баğlantısız maksimum kanca altı yüksekliği (m).
أقصى ارتفاع تحت الخطاف بدون ربط (m)



$$H_{SR} - 2 \text{ m.}$$

P09-1N	149.40.500
P09-3N	149.42.000
P09-4N	149.43.000
P09-5N	149.44.000
P09-6N	149.45.000
TR 12	146.30.000
T 12	126.21.500
TR 8RM	202.30.000
TR 8M	146.30.800
TR 4	800.32.300
T 4	126.32.000
TN 2	146.32.500

BTX 45/BEX 45	137.20.500
BTX 38R/BEX 38R	137.20.000
BTX 38/BEX 38	149.20.000
BTX 28/BEX 28	149.20.500
ABH 90	146.23.000
ABH 75	152.23.000
AR 12	137.21.000
AN 12	146.21.000
BE 442	146.24.850
BE 434	146.24.950
TMU 1.18	202.35.500

(H) TRASLACIÓN / TRAVELLING /

TRASLACION / ПЕРЕМЕЩЕНИЕ / RAY YÜRÜYÜŞLÜ / متحركة

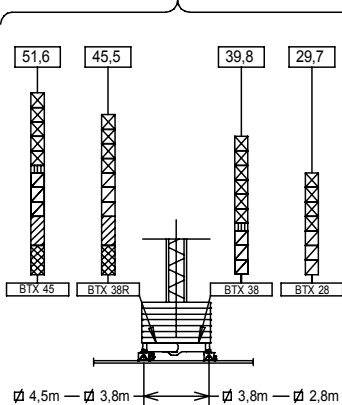

(H) ESTACIONARIA / STATIONARY /

STATIONAIRE / СТАЦИОНАРНОЕ СОСТОЯНИЕ / SABIT / ثابتة

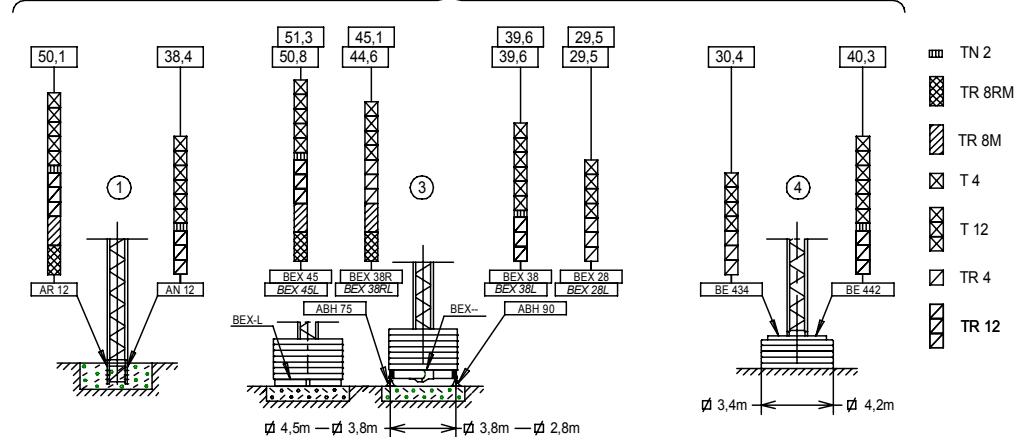

JASO EQUIPOS DE OBRAS Y CONSTRUCCIONES, S.L.



FEM 1001

Reservado el derecho a modificaciones sin previo aviso. Declinamos toda responsabilidad derivada de la información proporcionada / Subject to modification, without previous warning. This information is supplied without liability / L'entreprise se réserve le droit de procéder à des modifications sans préavis. Nous déclinons toute responsabilité quant aux informations fournies / Мы оставляем за собой право на внесение изменений без предварительного уведомления. Мы снимаем с себя любую ответственность в отношении предоставленной информации / Önceden bildirilmeksizin değiştirilme hakkı saklıdır. Verilen

Fecha / Date: 15-03-2013

bilgiler için hiçbir sorumluluk kabul etmemekteyiz / حقوق التغيير محفوظة دون إشعار مسبق. دون أدنى مسؤولية عن المعلومات المقدمة











CARGAS / LOADS / CHARGES / НАГРУЗКИ / YÜKLER / الأحمال **J37NS**

المتر / m	SR1 (t)	Cargas máximas / Maximum loads / Charges maximales / Максимальные нагрузки / Maksimum yük / أقصى حمولة / SR1-2 t								2 t @...[m]
		Alcance del gancho [m] / Hook reach [m] / Portée du crochet (m) / Радиус действия крюка (m) / Kancanın yüksekliği (m) / مدى الخطاف								
		37	35	32	30	27	25	22	20	
37 m	1	1,07	1,20	1,27	1,45	1,57	1,82	2	2	20,2
35 m	—	1,20	1,33	1,43	1,62	1,76	2	2	2	22,3
32 m	—	—	1,35	1,45	1,63	1,77	2	2	2	22,6
30 m	—	—	—	1,45	1,64	1,78	2	2	2	22,5
27 m	—	—	—	—	1,65	1,79	2	2	2	22,7
25 m	—	—	—	—	—	1,80	2	2	2	22,7
22 m	—	—	—	—	—	—	2	2	2	22
20 m	—	—	—	—	—	—	—	—	2	20

المتر / m	SR2 (t)	Cargas máximas / Maximum loads / Charges maximales / Максимальные нагрузки / Maksimum yük / أقصى حمولة / SR2-2,5 t								2,5 t @...[m]
		Alcance del gancho [m] / Hook reach [m] / Portée du crochet (m) / Радиус действия крюка (m) / Kancanın yüksekliği (m) / مدى الخطاف								
		37	35	32	30	27	25	22	15	
37 m	1	1,07	1,20	1,27	1,45	1,57	1,82	2	2,5	16,5
35 m	—	1,20	1,33	1,43	1,62	1,76	2	2,5	2,5	18,2
32 m	—	—	1,35	1,45	1,63	1,77	2	2,5	2,5	18,4
30 m	—	—	—	1,45	1,64	1,78	2	2,5	2,5	18,3
27 m	—	—	—	—	1,65	1,79	2	2,5	2,5	18,5
25 m	—	—	—	—	—	1,80	2	2,5	2,5	18,5
22 m	—	—	—	—	—	—	2,22	2,5	2,5	17,9
20 m	—	—	—	—	—	—	2,25	2,5	2,5	18,1

المتر / m	SR/DR (t)	Cargas máximas / Maximum loads / Charges maximales / Максимальные нагрузки / Maksimum yük / أقصى حمولة / SR/DR-2 t / 4 t										2 t / 4 t @...[m]
		Alcance del gancho [m] / Hook reach [m] / Portée du crochet (m) / Радиус действия крюка (m) / Kancanın yüksekliği (m) / مدى الخطاف										
		37	35	32	30	27	25	22	15	10		
37 m	0,85	0,92	1,05	1,12	1,30	1,42	1,67	1,87	2/2,62	2/4	19/10,3	
35 m	—	1,05	1,17	1,27	1,47	1,62	1,87	2/2,1	2/1,92	2/4	20,9/11,3	
32 m	—	—	1,20	1,30	1,50	1,65	1,9	2/2,15	2/2,97	2/4	21,1/11,4	
30 m	—	—	—	1,30	1,47	1,62	1,9	2/2,12	2/2,97	2/4	21,1/11,4	
27 m	—	—	—	—	1,5	1,65	1,92	2/2,15	1/3	2/4	21,3/11,5	
25 m	—	—	—	—	—	1,65	1,92	2/2,15	2/3	2/4	21,3/11,5	
22 m	—	—	—	—	—	—	1,85	2/2,07	2/2,87	2/4	20,6/11,1	
20 m	—	—	—	—	—	—	—	2/2,1	2/2,92	2/4	20/11,3	

CARACTERISTICAS DE MECANISMOS / MECHANISMS FEATURES / CARACTÉRISTIQUES DES MÉCANISMES / ХАРАКТЕРИСТИКИ МЕХАНИЗМОВ / MEKANİZMALARIN ÖZELLİKLERİ / الخصائص الآلية **J37NS**

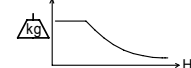
*opcional *optional *en option *опция *orsiyonel *اختياري												
	EC1846 SR2 13,2 kW	EC1856 SR1 13,2 kW	*EC2566 SR2 18,4 kW	*EC2580 SR1 18,4 kW	2,8/3,8 / 4,5m TG825VF 2x3 kW	OG408VF 3 kW	TC360 / *TC360VF 1,9 / *1,8 kW	TH1010 9,2 kW				
 m/min	1,3 2,5 2,5 46 23 5	1,1 2 2 56 28 6	1,3 2,5 2,5 64 32 8	1,1 2 2 82 41 10	0...25 m/min	0...0,4 0,4...0,8 r/min sl/min	30/60 m/min *0...30 *30...60 m/min	1 m/min				
 m/min		2,2 4 4 28 14 3		2,2 4 4 41 20,5 5		400V 50Hz P _{TOTAL} (EC1846/EC1856 + OG408VF + TC360) = 18,1 kW P _{TOTAL} (*EC2566/*EC2580 + OG408VF + *TC360VF) = *23,2 kW 480V 60Hz EC1846 / EC1856 / TC360 kW +20% *EC2566/*EC2580 / TH1010 m/min +20%						
 H	H ≤ SR 193 m DR 96,5 m		SR 189 m DR 94,5 m									

LASTRES INFERIORES / LOWER BALLASTS / LESTS INFÉRIEURS / НИЖНИЙ БАЛЛАСТ / ALT AĞIRLIK TAŞLARI / نقل **J37NS**





H (m)	H (m)											
	18	22	28	32	36	40	44	51,6				
BEX 45 / BTX 45 BEX45L	4		6		8		10		14			
BEX 38R / BTX 38R BEX 38 / BTX 38	4		6		8		10		14			
BEX 38RL / BEX 38L	4		6		8		10		14			
BEX 28 / BTX 28	6		8		10		-----		-----			
BE 434	18,3				30,4							
BE 442	26,1				30				40,3			

H: Altura bajo gancho / Height under hook / Hauteur maximale sous crochet / Высота под крюком / Kanca altı yüksekliği / الارتفاع أسفل الخطاف
 Para alturas intermedias tomar el lastre correspondiente a la altura superior / For intermediate heights take the ballast corresponding to the higher height / Pour les hauteurs intermédiaires, opter pour le lest correspondant à la hauteur immédiatement supérieure / Для промежуточных высот возьмите балласт, соответствующий большей высоте / Orta yükseklikler için daha üst bir yüksekliğe karşılık gelen ağırlığı alınız. / للارتفاعات البينية يرجى استخدام الثقل العائد للارتفاع الأعلى

LISTA DE EMBARQUE / PACKING LIST /

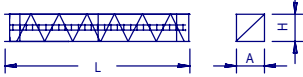
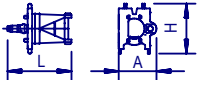
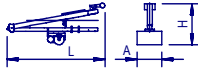
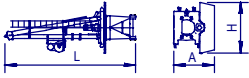
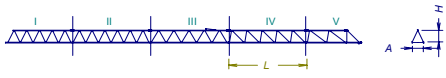
J37NS

LISTE DE COLISAGE / СПИСОК ПОСТАВКИ / ÇEKİ LİSTESİ / قائمة التحميل

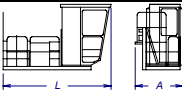
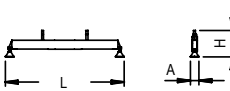
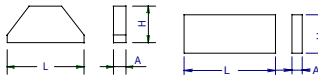
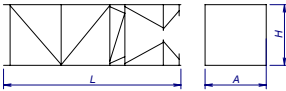
DENOMINACIÓN / DENOMINATION / DÉSIGNATION / НАЗВАНИЕ / AÇIKLAMA / اسم		L [m]	A [m]	H [m]	P / W [kg]	
Torre Tower Tour Башня Kule برج	TR 8RM – TR 8M TR 12 – T 12 TN 4RA – T4 TR 4 TN 2		8,07 12,01 4,06-4,09 3,96 2,29	1,19 1,19-1,18 1,19-1,18 1,18 1,19	1,19 1,19-1,18 1,19-1,18 1,18 1,19	2575-2515 2840-2025 1100-795 1070 785
Conjunto asiento pista, punta de torre y orientación Slewing table assembly, tower head and slewing mechanism Groupe pivot + porte-flèche + mécanisme d'orientation Сиденье площадки + верхняя секция башни + поворотный механизм Göbek + kulenin kafa bölümü + mekanizma مجموعة وحدة الدوران + رأس البرج + آلية الدوران			2,85	1,61	2,15	1860
Estructura punta de torre + Elevación Tower head structure + hoisting Structure porte-flèche + mécanisme de levage Структура верхней секции башни + подъемный механизм Kule kafa bölümü yapısı+vinç kulesi هيكل رأس البرج + آلية الرفع			4,45	1,19	2,31	1640
Torre asiento pista + punta de torre + orientación + elevación Slewing table + tower head + slewing + hoisting mechanism Tour pivot + base du porte-flèche + mécanisme d'orientation Сиденье площадки + основание верхней секции башни + поворотный механизм Döner tabla+kule kafa bölümü tabanı+mekanizma برج وحدة الدوران + قاعدة رأس البرج + الدوران + الرفع			5,96	1,61	2,40	3500
Tramo de pluma Jib section Tronçon de flèche Секция стрелы Vom bölümü أجزاء الذراع	P09 1N (I) P09 3N (II) P09 4N (III) P09 5N (IV) P09-6N (V)		10,13 10,15 10,15 5,26 2,13	1 0,87 0,87 0,87 0,86	1,13 1,12 1,03 1,02 1,02	1020 880 575 295 110
Polipasto / Hook assembly / Palan / Полиспаст / Kanca takımı / بكرة	SR DR		0,76 0,76	0,16 0,20	0,96 1,40	135 155
Carro / Trolley / Chariot / Грузовая тележка / Şaryo / عربة	SR DR		1,00 1,04	1,33 1,37	0,73 0,88	110 175
Contrapluma con plataformas / Counterjib with platforms Contre-flèche avec plateformes / Противовесная консоль с платформами / Platformlu kuyruk / الذراع المقابل مع المنصة			6,75	1,41	0,43	1200
Plataforma y cabina / Platform and cabin / Plateforme et cabine Платформа и кабина / Platform ve kabin / منصة وكابينة			3,69	1,63	2,25	820
Contrapeso / Counterweight / Contrepoids / Grande / Big / Grand / Большой / Büyük / كبير Противовес / Denge ağırlığı / موازنة معاكسة / Requeño / Small / Petit / Малый / Küçük / صغير	BEX 28 BEX 38 BEX 38R BEX 45 BTX 28 BTX 38 BTX 38R BTX 45		4,96 6,38 6,38 7,37 4,60 6,02 6,02 7,01	0,84 0,84 0,84 0,84 1,62 1,62 1,73 1,62	1,53 1,53 1,47 1,47 1,63 1,63 1,73 1,73	2870 3400 3800 4380 4005 4760 5230 5995
Lastre / Ballast / Lest / Балласт / Alt ağırlık taşları / ثقل	☑ 2,8m ☑ 3,8m - ☑4,5m BE 442 BE 434		3,00 4,00 2,09 3,40	0,44 0,34 0,34 0,34	1,30 1,30 2,10 1,69	3700 4100 3450 4300
Torre de montaje / Jacking cage / Tour de montage / Монтажная башня / Kaldırma kafesi / برج التركيب			7,14	1,76	1,71	3200
Torre de montaje sin puerta, carro, plataforma carro y viga de apoyo Jacking cage without door, trolley, trolley platform and beam assembly Tour de montage sans porte, chariot, plateforme de chariot et poutre de soutien Монтажная башня без двери, грузовой тележки, платформы грузовой тележки и опорной балки Kapisız kaldırma kafesi, vinç köprüsü arabası, vinç köprüsü arabası platformu ve giriş takımı برج التركيب بدون بوابة ، وعربة ومنصة متحركة وعارضة تدعيم		TMU 1.18 	7,14	1,76	1,71	2450



JASO EQUIPOS DE OBRAS Y CONSTRUCCIONES, S.L.

FEM 1001

Reservado el derecho a modificaciones sin previo aviso. Declinamos toda responsabilidad derivada de la información proporcionada / Subject to modification, without previous warning. This information is supplied without liability / L'entreprise se réserve le droit de procéder à des modifications sans préavis. Nous déclinons toute responsabilité quant aux informations fournies / Мы оставляем за собой право на внесение изменений без предварительного уведомления. Мы снимаем с себя любую ответственность в отношении предоставленной информации / Önceden bildirilmeksizin değiştirilme hakkı saklıdır. Verilen

Fecha / Date: 15-03-2013

bilgiler için hiçbir sorumluluk kabul etmemekteyiz / حقوق التغيير محفوظة دون إشعار مسبق. دون أدنى مسؤولية عن المعلومات المقدمة

T	H							H	T		
1	4,5	T4	T4	T4	T4	T4	T4	126.32.000	4,5	1	
2	8,4						3,96		8,4	2	
3	12,4						11,88	T 12	126.31.500	20,3	3
4	24,3	T 12									
			TR 12	TR 12	TR 12	TR 12	11,88	TR 12	146.30.000	32,2	4
5	36,2		TR 12								
			TR 8M	TR 8M	TR 8M	TR 8M	7,86	TR 8M	146.30.800	40,1	5
6	44		TR 8				0,83	TX-90 / TXXR	202.36.500		
			TX-90 / TXXR	TX-90 / TXXR	TX-90 / TXXR	TX-90 / TXXR	0,83	T 3-90	133.32.000	43,9	6
			T 3-90	T 3-90	T 3-90	T 3-90	2,95			46,8	7
		AR 12								49,7	8
9	52,7							T6-150A		55,5	9
10	58,5	AN 90		T6-150A	T6-150A	T6-150A	5,82	T6-150A	161.31.300	61,3	10
11	64,3			T6-150	T6-150	T6-150		T6-150	161.31.000	65,2	11
				TL20 / Tx 150	TL20 / Tx 150	TL20 / Tx 150	3,93	TL20 / Tx 150	161.36.000	69,1	12
				TL20	TL20	TL20	3,89	TL20	153.31.000	73	13
				TS20A	TS20A	TS20A	3,87	TS20A		76,9	14
				TS20	TS20	TS20	3,87	TS20		80,7	15
				AS 20	AS 20	AS 20	3,87	AS 20		84,6	16
				ASR 20	ASR 20	ASR 20	3,87	ASR 20		88,5	17

AR 12	137.21.000										
ARD 12	137.21.800										
AN 90	133.21.000	ALD 20	160.21.250								
AND 90	133.21.800	AS 20	160.21.010								
AN 150	161.21.000	ASD 20/24	160.21.080								
AND 150	161.21.050	ASR 20	160.21.200								
AL 20	153.21.800	ASRD 20/24	156.21.000								

T: Torre / Tower / Tour / Башни / Kuleler / أبراج
H: Altura / Height / Hauteur / Высота / Yükseklik / ارتفاع

Otras configuraciones de torre / Other tower configuration / Autres configurations / Прочие конфигурации / Diğer konfigürasyonlar / مكونات أخرى

Transporte / Transport / Transport / Транспортировка / Taşıma / نقل

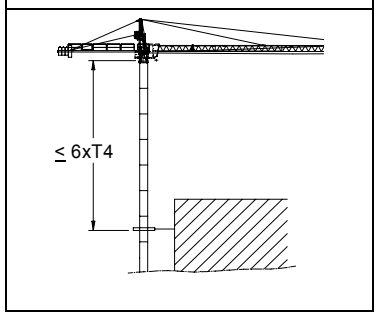
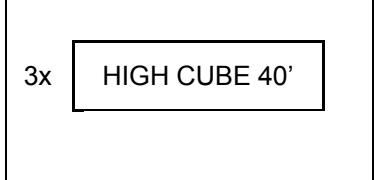
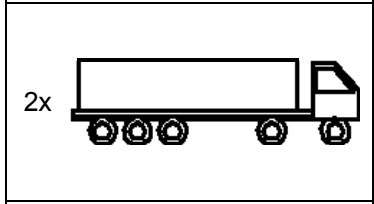
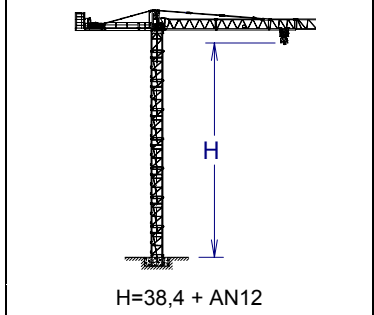

TREPADO / CLIMBING / TÉLESCOPAGE / ЛЕСТНИЦА / TIRMANMA / التسلق

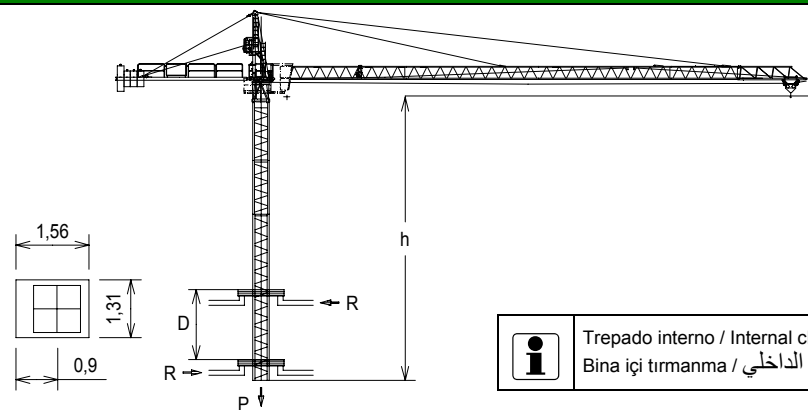

$h_{max} = 3xTR4 + 6xT4$

	▶	■
h (m)	36	
D (m)	5,1 - 10	
P (KN)	403	378
Rmax (KN)	142	251

TR4: 800.32.300

Trepado interno / Internal climbing. / Télescopage intérieur / Внутренняя лестница / Bina içi tirmanma / التسلق الداخلي

- Wiento fuera de servicio / Out of service wind / Vitesse du vent hors service / Ветровая нагрузка в покое / Rüzgar devre dışı / الريح خارج الخدمة
- Consultar / Consult / Nous consulter / Консультируйтесь / Danışınız / الرجوع إلى
- En servicio / In service / En service / В работе / Devrede / في الخدمة
- Fuera de servicio / Out of service / Hors service / В покое / Devre dışı / خارج الخدمة



JASO EQUIPOS DE OBRAS Y CONSTRUCCIONES, S.L.

Ctra./Rd. Madrid - Irún Km. 415
 20.213 IDIAZABAL [Gipuzkoa]
 ESPAÑA / SPAIN
 P.O. Box, 23 - 20.200 BEASAIN

Tel. +34 943 - 18 70 00
 Fax. +34 943 - 18 70 20
 E-mail: jaso@jaso.com
 http://www.jaso.com

Fecha / Date: 15-03-2013

Reservado el derecho a modificaciones sin previo aviso. Declinamos toda responsabilidad derivada de la información proporcionada / Subject to modification, without previous warning. This information is supplied without liability / L'entreprise se réserve le droit de procéder à des modifications sans préavis. Nous déclinons toute responsabilité quant aux informations fournies / Мы оставляем за собой право на внесение изменений без предварительного уведомления. Мы снимаем с себя любую ответственность в отношении предоставленной информации / Önceden bildirilmeksizin değiştirilme hakkı saklıdır. Verilen bilgiler için hiçbir sorumluluk kabul etmemekteyiz / حقوق التغيير محفوظة دون إشعار مسبق، دون أخذ مسؤلية عن المعلومة المقدمة



DELEGACION / DELEGATION