

GRU A MONTAGGIO RAPIDO
 GRUE A MONTAGE RAPIDE
 GRUA DE RAPIDO MONTAJE
 GRUA DE MONTAGEM RAPIDA
 QUICK SELFERECTING CRANE
 HYDRAULISCHER SCHNELLMONTAGEKRAN

Curve di carico – Courbes de charges – Load diagrams – LastKurven – Curvas de cargas

	<table border="1"> <tr><td>3</td><td>29</td><td>34</td><td>m</td></tr> <tr><td>800</td><td>800</td><td>800</td><td>kg</td></tr> </table>	3	29	34	m	800	800	800	kg	OP	<table border="1"> <tr><td>3</td><td>29</td><td>34</td><td>m</td></tr> <tr><td>1000</td><td>1000</td><td>1000</td><td>kg</td></tr> </table>	3	29	34	m	1000	1000	1000	kg														
3	29	34	m																														
800	800	800	kg																														
3	29	34	m																														
1000	1000	1000	kg																														
	<table border="1"> <tr><td>3</td><td>10.8</td><td>12</td><td>14</td><td>16</td><td>18</td><td>20</td><td>22</td><td>24</td><td>26</td><td>28</td><td>30</td><td>32</td><td>35</td><td>m</td></tr> <tr><td>4000</td><td>4000</td><td>3480</td><td>2880</td><td>2440</td><td>2110</td><td>1860</td><td>1650</td><td>1490</td><td>1350</td><td>1230</td><td>1130</td><td>1040</td><td>950</td><td>kg</td></tr> </table>	3	10.8	12	14	16	18	20	22	24	26	28	30	32	35	m	4000	4000	3480	2880	2440	2110	1860	1650	1490	1350	1230	1130	1040	950	kg		
3	10.8	12	14	16	18	20	22	24	26	28	30	32	35	m																			
4000	4000	3480	2880	2440	2110	1860	1650	1490	1350	1230	1130	1040	950	kg																			
	<table border="1"> <tr><td>3</td><td>11.2</td><td>12</td><td>14</td><td>16</td><td>18</td><td>20</td><td>22</td><td>24</td><td>26</td><td>28</td><td>30</td><td>m</td></tr> <tr><td>4000</td><td>4000</td><td>3670</td><td>3030</td><td>2570</td><td>2230</td><td>1960</td><td>1750</td><td>1570</td><td>1420</td><td>1300</td><td>1200</td><td>kg</td></tr> </table>	3	11.2	12	14	16	18	20	22	24	26	28	30	m	4000	4000	3670	3030	2570	2230	1960	1750	1570	1420	1300	1200	kg						
3	11.2	12	14	16	18	20	22	24	26	28	30	m																					
4000	4000	3670	3030	2570	2230	1960	1750	1570	1420	1300	1200	kg																					
	<table border="1"> <tr><td>3</td><td>19.3</td><td>20</td><td>22</td><td>24</td><td>26</td><td>28</td><td>30</td><td>32</td><td>35</td><td>m</td></tr> <tr><td>2000</td><td>2000</td><td>1910</td><td>1700</td><td>1540</td><td>1400</td><td>1280</td><td>1180</td><td>1090</td><td>1000</td><td>kg</td></tr> </table>	3	19.3	20	22	24	26	28	30	32	35	m	2000	2000	1910	1700	1540	1400	1280	1180	1090	1000	kg										
3	19.3	20	22	24	26	28	30	32	35	m																							
2000	2000	1910	1700	1540	1400	1280	1180	1090	1000	kg																							
	<table border="1"> <tr><td>3</td><td>20.2</td><td>22</td><td>24</td><td>26</td><td>28</td><td>30</td><td>m</td></tr> <tr><td>2000</td><td>2000</td><td>1800</td><td>1650</td><td>1480</td><td>1350</td><td>1250</td><td>kg</td></tr> </table>	3	20.2	22	24	26	28	30	m	2000	2000	1800	1650	1480	1350	1250	kg																
3	20.2	22	24	26	28	30	m																										
2000	2000	1800	1650	1480	1350	1250	kg																										
	<table border="1"> <tr><td>3</td><td>16</td><td>18</td><td>20</td><td>22</td><td>24</td><td>26</td><td>28</td><td>30</td><td>32</td><td>35</td><td>m</td></tr> <tr><td>2500</td><td>2500</td><td>2110</td><td>1910</td><td>1700</td><td>1540</td><td>1400</td><td>1280</td><td>1180</td><td>1090</td><td>1000</td><td>kg</td></tr> </table>	3	16	18	20	22	24	26	28	30	32	35	m	2500	2500	2110	1910	1700	1540	1400	1280	1180	1090	1000	kg								
3	16	18	20	22	24	26	28	30	32	35	m																						
2500	2500	2110	1910	1700	1540	1400	1280	1180	1090	1000	kg																						
	<table border="1"> <tr><td>3</td><td>16</td><td>18</td><td>20</td><td>22</td><td>24</td><td>26</td><td>28</td><td>30</td><td>m</td></tr> <tr><td>2500</td><td>2500</td><td>2230</td><td>2000</td><td>1800</td><td>1650</td><td>1480</td><td>1350</td><td>1250</td><td>kg</td></tr> </table>	3	16	18	20	22	24	26	28	30	m	2500	2500	2230	2000	1800	1650	1480	1350	1250	kg												
3	16	18	20	22	24	26	28	30	m																								
2500	2500	2230	2000	1800	1650	1480	1350	1250	kg																								
	<table border="1"> <tr><td>3</td><td>11.2</td><td>14</td><td>m</td></tr> <tr><td>4000</td><td>4000</td><td>3000</td><td>kg</td></tr> </table>	3	11.2	14	m	4000	4000	3000	kg		<table border="1"> <tr><td>3</td><td>14</td><td>m</td></tr> <tr><td>2000</td><td>2000</td><td>kg</td></tr> </table>	3	14	m	2000	2000	kg																
3	11.2	14	m																														
4000	4000	3000	kg																														
3	14	m																															
2000	2000	kg																															

Reazioni – Reactions – Réactions – Eckdrücke – Reacciones – Reacções

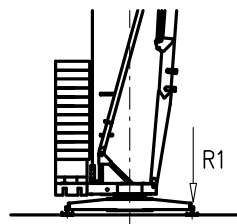

R1 ● 25 t ■ 17.5 t

▲ 15 t ○ 26.52 t

- | | | |
|-------------------------------|---------------------------------------|--------------------------------------|
| ● Reazioni in servizio | ● Reactions in service | ● Réactions en service |
| ■ Reazioni fuori servizio | ■ Reactions out of service | ■ Réactions hors service |
| ▲ Peso della gru senza assali | ▲ Dead weight without transport axles | ▲ Poids de construction sans essieux |
| ○ Peso zavorra rotante | ○ Ballast weight | ○ Poids du lest |
-
- | | | |
|--|--|---|
| ● Reaktionskräfte in betrieb | ● Reacciones en servicio | ● Em serviço |
| ■ Reaktionskräfte außer betrieb | ■ Reacciones fuera de servicio | ■ Fora de serviço |
| ▲ Konstruktionsgewicht ohne transportachse | ▲ Peso de la grua sin tren de transporte | ▲ Peso de la grua sem carro de transporte |
| ○ Ballastgewicht | ○ Peso de lastre | ○ Peso de lastre rotativo |

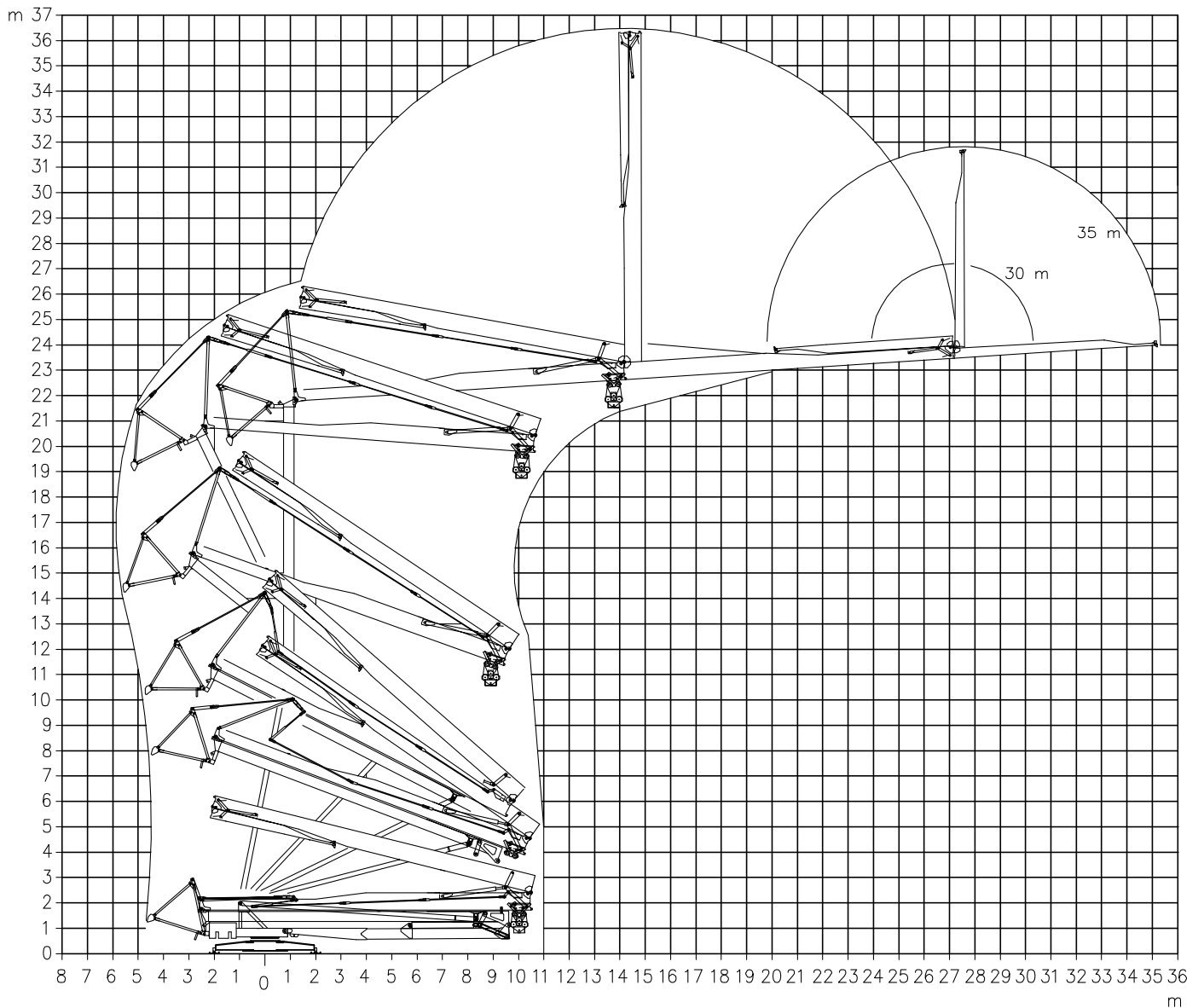

Montaggio – Montage – Erection – Montage – Montaje – Montagem



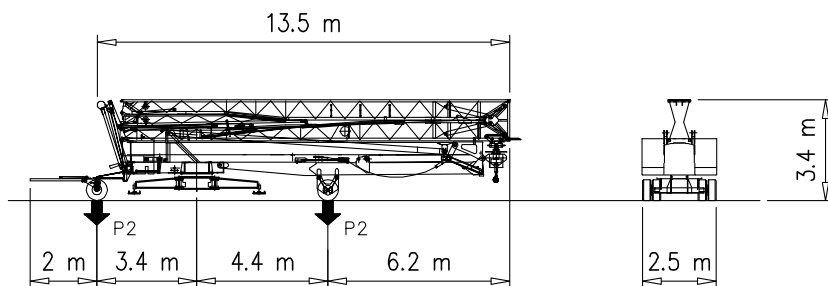



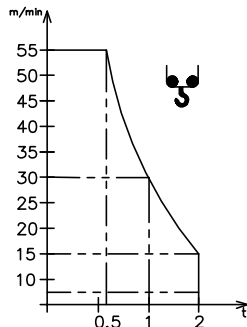
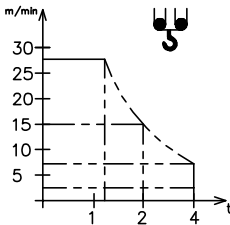
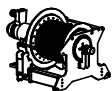

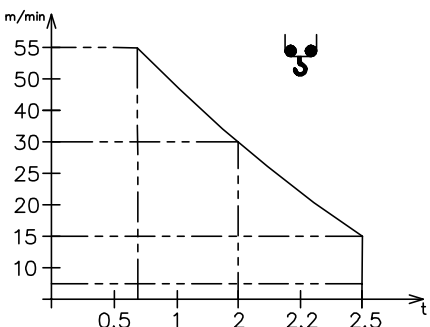
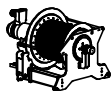
Trasporto – Transport – Transport – Transport – Transporte



P1	kg	9800
P2	kg	12380
Ptot	kg	22180

V12.40 Sollevamento Hoisting Levage Heben Elevaciòn Elevaçao	m/min							V12.40 8.8 kW (12 Hp) 18 kVA 
		t	4	15	30			
	m/min							
		t	2	7.5	15			
V15.45 Sollevamento Hoisting Levage Heben Elevaciòn Elevaçao	m/min						V15.45 11 kW (15 Hp) 20 kVA 	
		t	4	15	30			55
	m/min							
		t	2.5	2.5	2.0			0.7

Carrello Trolleying Distribuciòn			1a			
			2a	0 → 45	m/min	2.2 kW / 3 kW
			3a			
			1a			
			2a	0 → 17	m/min	3 kW
			3a			
	1a					
	2a	0 → 17	m/min	3 kW		
	3a					
Rotazione Slewing Orientaciòn			1a			
			2a	0 → 0.8	giri/min tr/min rp/min	2.2 kW
			3a			

Rete elettrica – Réseau – Mains supply – Netzstrom – Red	400V – 50 Hz
Potenza elettrica necessaria – Puissance électrique nécessaire Necessary electric power – Anschlusswert – Potencia electrica necesaria	V12.40 18 kVA V15.45 20 kVA
Conforme alla direttiva 2000/14/CE sul livello acustico Conforme à la directive 2000/14/CE sur le niveau acoustique In compliance with the 2000/14/CE instruction on noise level Germäss EWG-Richtlinie 2000/14/CE über Schall-Leistungspegel Conforme con la directiva 2000/14/CE sobre el nivel acustico	FEM 1.001-A3

 FMgru s.r.l.
 via Emilia 11-29010 Pontenure PC ITALY
 tel. 0523/510446 ric.aut. fax 0523/510365
 www.fmgru.it e-mail: info@fmgru.com



Documento commerciale non contrattuale
Per tutte le informazioni tecniche riferirsi
alle corrispondenti istruzioni

Unverbindliches Vertriebsdokument.
Für technische Informationen, siehe die
entsprechenden Anweisungen.

This commercial document is not legally
binding. For any technical information, please
refer to the corresponding instructions.

Documento commercial no contractual
Para cualquier información técnica,
ver la noticia correspondiente.

Code: 15ICA37B80A0			
Ed.	Data	Rev	Data
1	05.06.03	2	19.03.10